



Dual P-channel -30V, SOP-8 MOSFET 雙 P-溝道場效應管

■ Features 特點

Low on-resistance and maximum DC current capability 低導通電阻和最大直流電流能力

Super high density cell design 超高元胞密度設計

-30V/-5.1A, $R_{DS(ON)}=40m\Omega$ (Type)@VGS=-10V

-30V/-4.2A, $R_{DS(ON)}=57m\Omega$ (Type)@VGS=-4.5V

■ Applications 應用

Power Management 電源管理

Load Switch 負載開關

PWM Applications 脈寬調製應用

■ Internal Schematic Diagram 內部結構

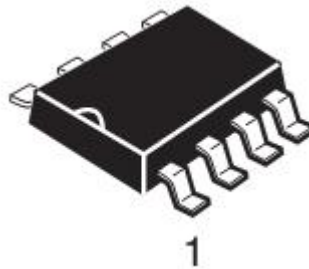
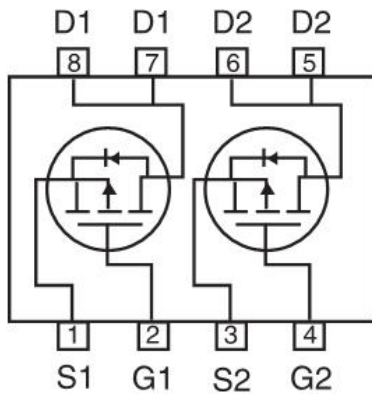

■ Absolute Maximum Ratings 最大額定值

Characteristic 特性參數	Symbol 符號	Rat 額定值	Unit 單位
Drain-Source Voltage 漏極-源極電壓	BV_{DSS}	-30	V
Gate- Source Voltage 柵極-源極電壓	V_{GS}	± 20	V
Drain Current (continuous)漏極電流-連續	I_D (at $T_C = 25^\circ C$)	-5.1	A
Drain Current (pulsed)漏極電流-脈沖	I_{DM}	-20	A
Total Device Dissipation 總耗散功率	P_{TOT} (at $T_C = 25^\circ C$)	2.5	W
Thermal Resistance Junction-Case 熱阻	$R_{\theta JC}$	30	$^\circ C/W$
Thermal Resistance Junction-Ambient 熱阻	$R_{\theta JA}$	50	$^\circ C/W$
Junction/Storage Temperature 結溫/儲存溫度	T_J, T_{stg}	-55~150	$^\circ C$



■ Electrical Characteristics 電特性

($T_A=25^{\circ}\text{C}$ unless otherwise noted 如無特殊說明，溫度為 25°C)

Characteristic 特性參數	Symbol 符號	Min 最小值	Typ 典型值	Max 最大值	Unit 單位
Drain-Source Breakdown Voltage 漏極-源極擊穿電壓($I_D=-250\mu\text{A}, V_{GS}=0\text{V}$)	BV_{DSS}	-30	—	—	V
Gate Threshold Voltage 柵極開啓電壓($I_D=-250\mu\text{A}, V_{GS}=V_{DS}$)	$V_{GS(th)}$	-1	-1.5	-2.5	V
Zero Gate Voltage Drain Current 零柵壓漏極電流($V_{GS}=0\text{V}, V_{DS}=-30\text{V}$)	I_{DSS}	—	—	-1	μA
Gate Body Leakage 柵極漏電流($V_{GS}=\pm 20\text{V}, V_{DS}=0\text{V}$)	I_{GSS}	—	—	± 100	nA
Static Drain-Source On-State Resistance 靜態漏源導通電阻($I_D=-5.1\text{A}, V_{GS}=-10\text{V}$) ($I_D=-4.2\text{A}, V_{GS}=-4.5\text{V}$)	$R_{DS(ON)}$	—	40 57	55 85	$\text{m}\Omega$
Forward Trans-conductance 正向傳輸導納($V_{DS}=-5\text{V}, I_D=-4.5\text{A}$)	g_{FS}	4	—	—	S
Diode Forward Voltage Drop 內附二極管正向壓降($I_{SD}=-5.1\text{A}, V_{GS}=0\text{V}$)	V_{SD}	—	—	-1.2	V
Input Capacitance 輸入電容 ($V_{GS}=0\text{V}, V_{DS}=-15\text{V}, f=1\text{MHz}$)	C_{ISS}	—	520	—	pF
Common Source Output Capacitance 共源輸出電容($V_{GS}=0\text{V}, V_{DS}=-15\text{V}, f=1\text{MHz}$)	C_{OSS}	—	130	—	pF
Reverse Transfer Capacitance 反向傳輸電容 ($V_{GS}=0\text{V}, V_{DS}=-15\text{V}, f=1\text{MHz}$)	C_{RSS}	—	70	—	pF
Total Gate Charge 總柵極電荷密度 ($V_{DS}=-15\text{V}, I_D=-5.1\text{A}, V_{GS}=-10\text{V}$)	Q_g	—	3	—	nC
Gate Source Charge 柵源電荷密度 ($V_{DS}=-15\text{V}, I_D=-5.1\text{A}, V_{GS}=-10\text{V}$)	Q_{gs}	—	2.2	—	nC
Gate Drain Charge 柵漏電荷密度 ($V_{DS}=-15\text{V}, I_D=-5.1\text{A}, V_{GS}=-10\text{V}$)	Q_{gd}	—	3	—	nC
Turn-On Delay Time 開啓延遲時間 ($V_{DS}=-15\text{V}, I_D=-1\text{A}, R_{GEN}=6\Omega, V_{GS}=-10\text{V}$)	$t_{d(on)}$	—	7	—	ns
Turn-On Rise Time 開啓上升時間 ($V_{DS}=-15\text{V}, I_D=-1\text{A}, R_{GEN}=6\Omega, V_{GS}=-10\text{V}$)	t_r	—	13	—	ns
Turn-Off Delay Time 關斷延遲時間 ($V_{DS}=-15\text{V}, I_D=-1\text{A}, R_{GEN}=6\Omega, V_{GS}=-10\text{V}$)	$t_{d(off)}$	—	14	—	ns
Turn-On Fall Time 開啓下降時間 ($V_{DS}=-15\text{V}, I_D=-1\text{A}, R_{GEN}=6\Omega, V_{GS}=-10\text{V}$)	t_f	—	9	—	ns



■ TYPICAL CHARACTERISTIC CURVE

典型特性曲線

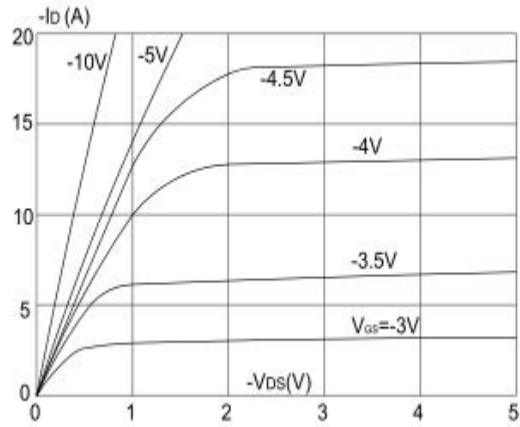

Figure 1: Output Characteristics

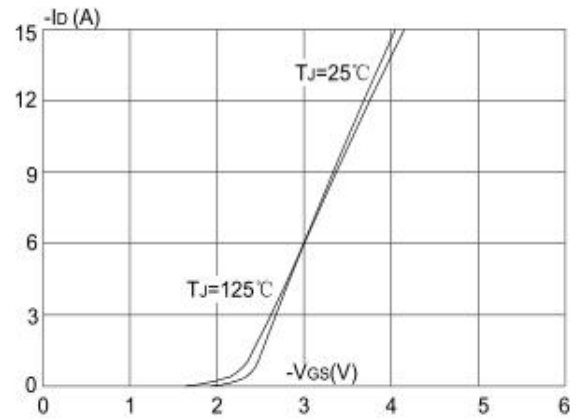

Figure 2: Transfer Characteristics

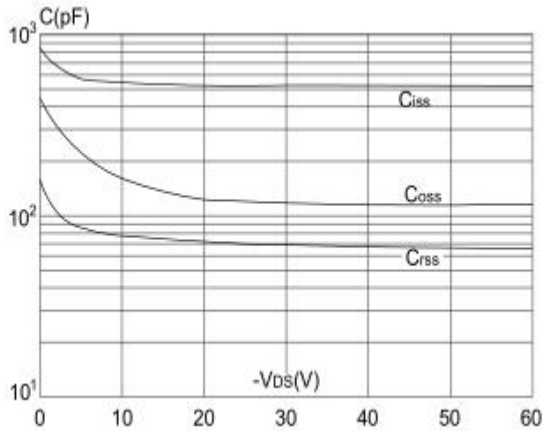

Figure 3: Capacitance

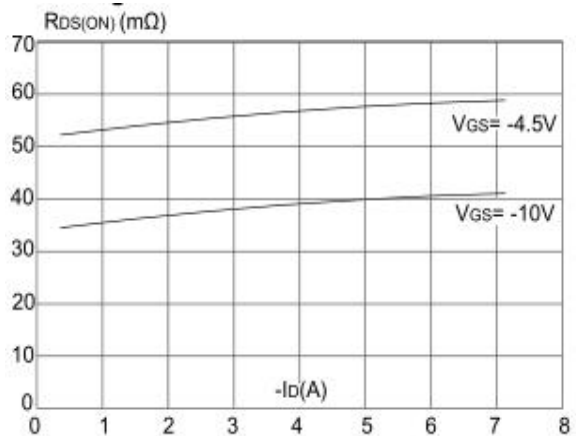

Figure 4: Rds(on) - Drain Current

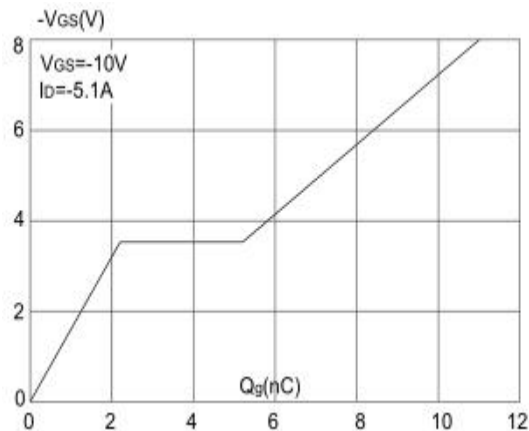

Figure 5: Gate-Charge Characteristics

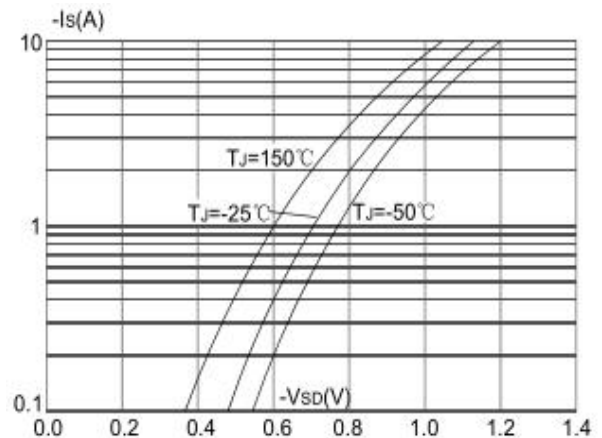

Figure 6: Body Diode Characteristics



■ TYPICAL CHARACTERISTIC CURVE

典型特性曲線

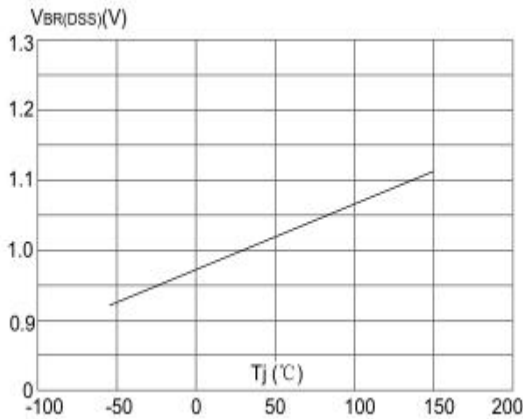

Figure 7: Breakdown Voltage vs. Junction Temperature

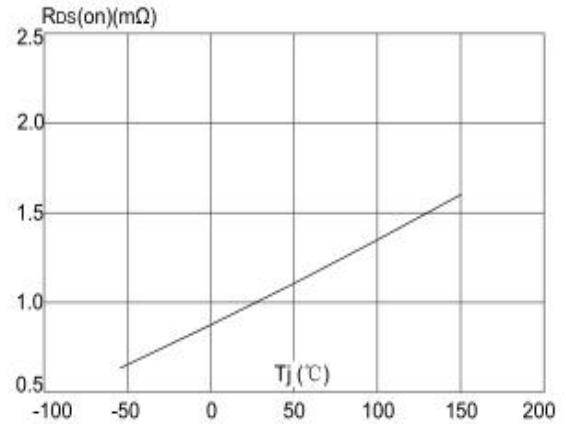

Figure 8: On Resistance vs. Junction Temperature

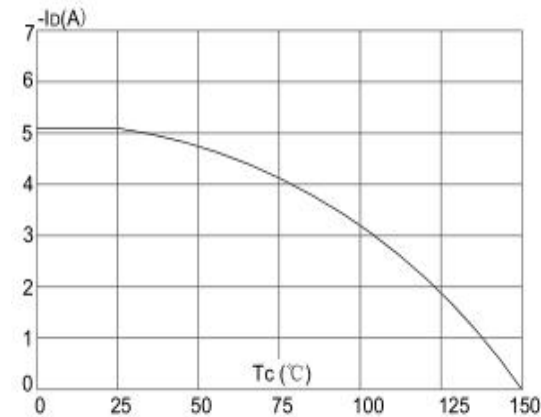

Figure 9: Drain Current vs. Case Temperature

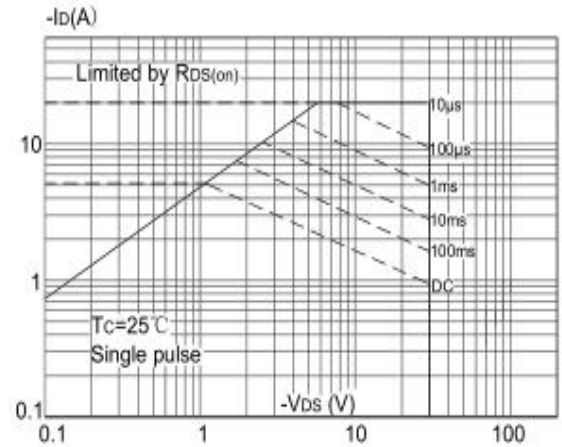

Figure 10: Safe Operating Area

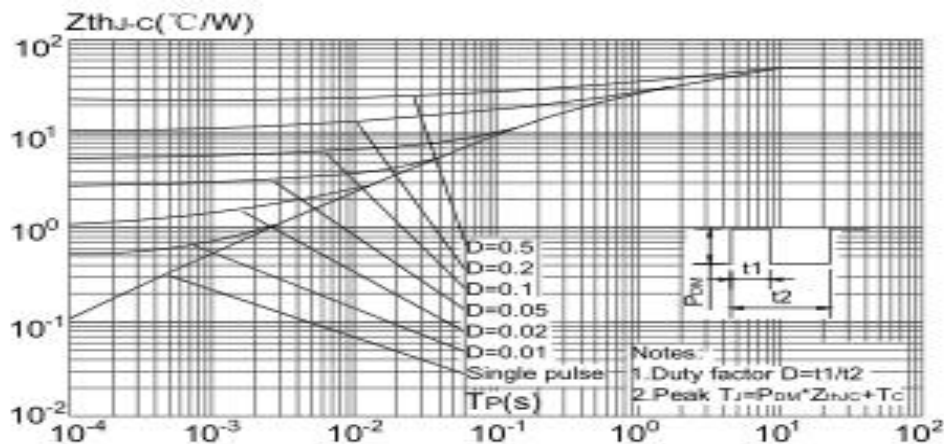
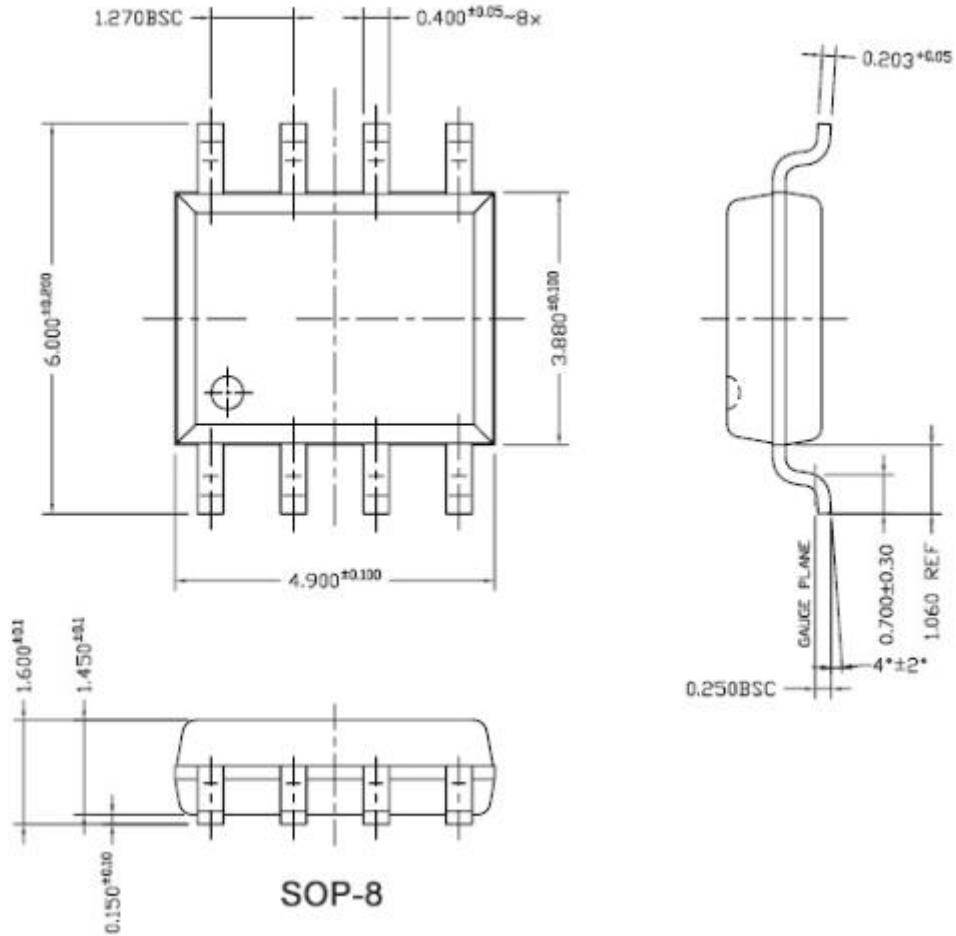

Figure 11: Effective Transient Thermal Impedance, Junction-to-Ambient(SOP-8)



■DIMENSION 外形封裝尺寸



■MARKING 印字

