



N-channel 30V, 75A, TO-252 Power MOSFET 功率場效應管

■ **Features 特點**

Low on-resistance and maximum DC current capability 低導通電阻和最大直流電流能力

10V Logic Level Control 邏輯電平控制

$R_{DS(ON)}$ Type4.5mΩ@VGS=10V

$R_{DS(ON)}$ Type5mΩ@VGS=4.5V

■ **Applications 應用**

Power Management in Note book 筆記本電源管理

Portable Equipment 便攜式設備

Primary Side Switch 初邊開關

H-bridge Inverter 半橋變換

Car Charger 汽車充電

■ **Internal Schematic Diagram 內部結構**

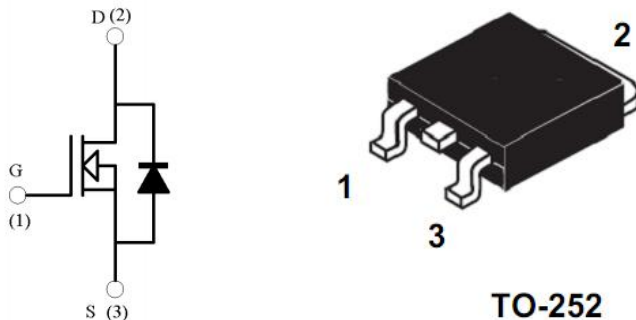

■ **Absolute Maximum Ratings 最大額定值**

Characteristic 特性參數	Symbol 符號	Rat 額定值	Unit 單位
Drain-Source Voltage 漏極-源極電壓	BV_{DSS}	30	V
Gate- Source Voltage 柵極-源極電壓	V_{GS}	±20	V
Drain Current (continuous)漏極電流-連續	I_D (at $T_C = 25^\circ C$)	75	A
Drain Current (pulsed)漏極電流-脈沖	I_{DM}	260	A
Total Device Dissipation 總耗散功率	P_{TOT} (at $T_C = 25^\circ C$)	62.5	W
Avalanche energy, single pulsed 雪崩能量	EAS	109	mJ
Thermal Resistance Junction to Case 熱阻	$R_{\theta JC}$	2.4	$^\circ C/W$
Junction/Storage Temperature 結溫/儲存溫度	T_J, T_{stg}	-50~175	$^\circ C$



■ Electrical Characteristics 電特性

($T_A=25^{\circ}\text{C}$ unless otherwise noted 如無特殊說明，溫度為 25°C)

Characteristic 特性參數	Symbol 符號	Min 最小值	Typ 典型值	Max 最大值	Unit 單位
Drain-Source Breakdown Voltage 漏極-源極擊穿電壓($I_D=250\mu\text{A}, V_{GS}=0\text{V}$)	BV_{DSS}	30	—	—	V
Gate Threshold Voltage 柵極開啓電壓($I_D=250\mu\text{A}, V_{GS}=V_{DS}$)	$V_{GS(th)}$	1	1.6	2.5	V
Zero Gate Voltage Drain Current 零柵壓漏極電流($V_{GS}=0\text{V}, V_{DS}=30\text{V}$)	I_{DSS}	—	—	1	μA
Gate Body Leakage 柵極漏電流($V_{GS}=\pm 20\text{V}, V_{DS}=0\text{V}$)	I_{GSS}	—	—	± 100	nA
Static Drain-Source On-State Resistance 静态漏源導通電阻($I_D=40\text{A}, V_{GS}=10\text{V}$) ($I_D=30\text{A}, V_{GS}=7\text{V}$)	$R_{DS(ON)}$	—	4.6 5.1	5.8 6.5	$\text{m}\Omega$
Diode Forward Voltage Drop 內附二極管正向壓降($I_{SD}=20\text{A}, V_{GS}=0\text{V}$)	V_{SD}	—	—	1.2	V
Input Capacitance 輸入電容 ($V_{GS}=0\text{V}, V_{DS}=15\text{V}, f=1\text{MHz}$)	C_{ISS}	—	1335	—	pF
Common Source Output Capacitance 共源輸出電容($V_{GS}=0\text{V}, V_{DS}=15\text{V}, f=1\text{MHz}$)	C_{OSS}	—	210	—	pF
Reverse Transfer Capacitance 反向傳輸電容 ($V_{GS}=0\text{V}, V_{DS}=15\text{V}, f=1\text{MHz}$)	C_{RSS}	—	140	—	pF
Total Gate Charge 總柵極電荷密度 ($V_{DS}=15\text{V}, I_D=30\text{A}, V_{GS}=10\text{V}$)	Q_g	—	5.5	—	nC
Gate Source Charge 柵源電荷密度 ($V_{DS}=15\text{V}, I_D=30\text{A}, V_{GS}=10\text{V}$)	Q_{gs}	—	3.3	—	nC
Gate Drain Charge 柵漏電荷密度 ($V_{DS}=15\text{V}, I_D=30\text{A}, V_{GS}=10\text{V}$)	Q_{gd}	—	4.8	—	nC
Turn-On Delay Time 開啓延遲時間 ($V_{DS}=15\text{V}, I_D=15\text{A}, R_{GEN}=3.3\Omega, V_{GS}=10\text{V}$)	$t_{d(on)}$	—	11	—	ns
Turn-On Rise Time 開啓上升時間 ($V_{DS}=15\text{V}, I_D=15\text{A}, R_{GEN}=3.3\Omega, V_{GS}=10\text{V}$)	t_r	—	30	—	ns
Turn-Off Delay Time 關斷延遲時間 ($V_{DS}=15\text{V}, I_D=15\text{A}, R_{GEN}=3.3\Omega, V_{GS}=10\text{V}$)	$t_{d(off)}$	—	24	—	ns
Turn-On Fall Time 開啓下降時間 ($V_{DS}=15\text{V}, I_D=15\text{A}, R_{GEN}=3.3\Omega, V_{GS}=10\text{V}$)	t_f	—	6	—	ns

■ TYPICAL CHARACTERISTIC CURVE

典型特性曲线

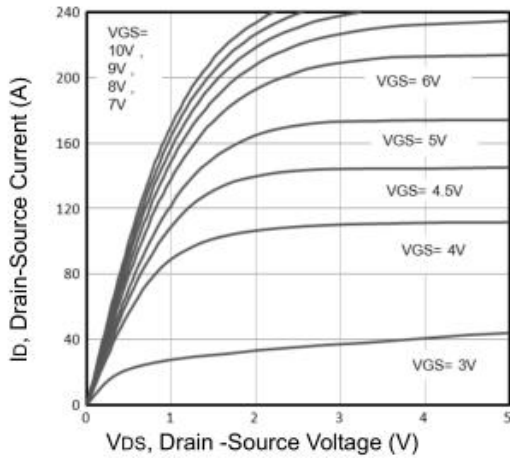

Figure 1: Output Characteristics

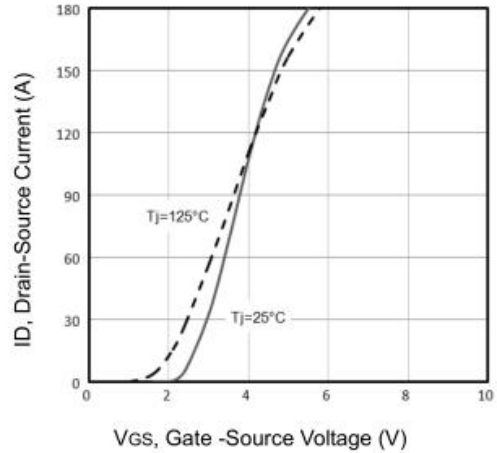

Figure 2: Transfer Characteristics

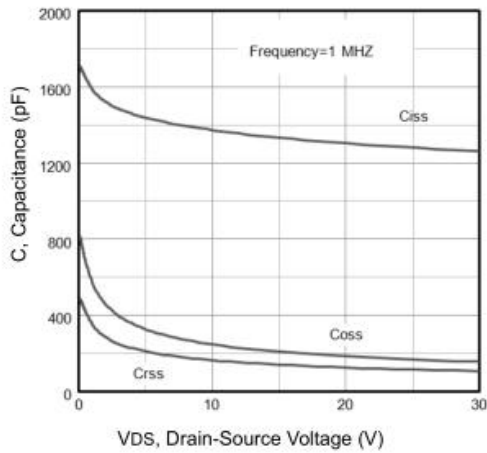

Figure 3: Capacitance

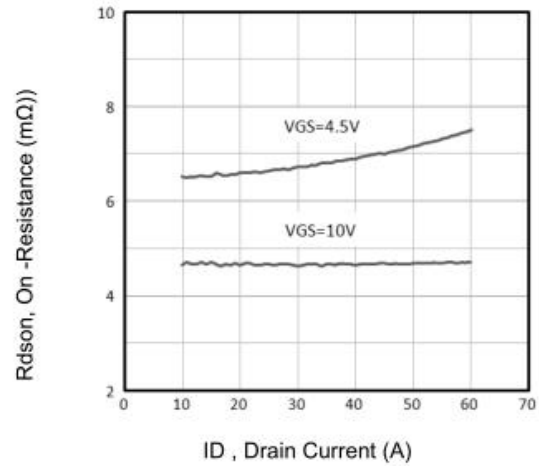

Figure 4: Rds(on) - Drain Current

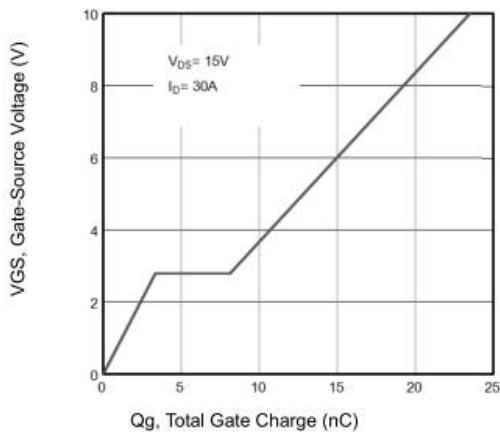

Figure 5: Gate-Charge Characteristics

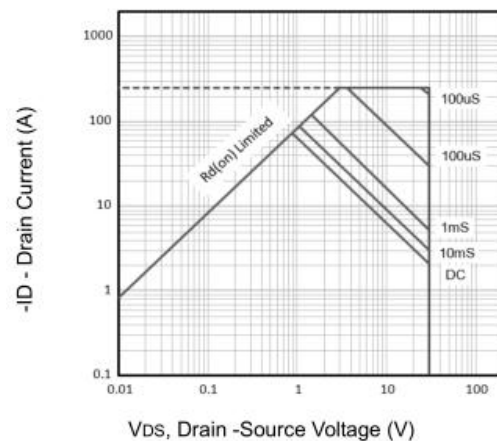
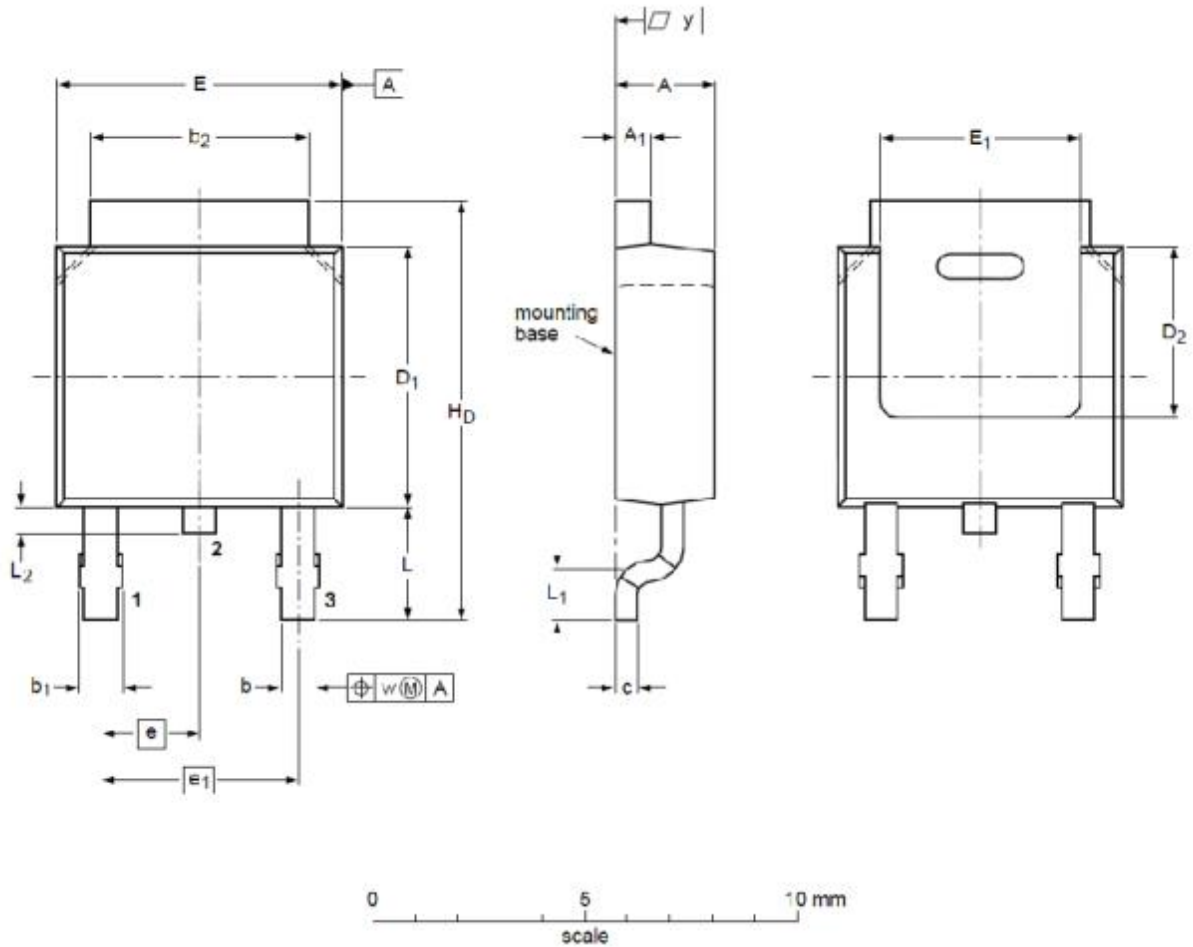

Figure 6: Safe Operating Area



■DIMENSION 外形封裝尺寸



DIMENSIONS (unit : mm)

Symbol	Min	Typ	Max	Symbol	Min	Typ	Max
A	2.22	2.30	2.38	A ₁	0.4	0.53	0.65
b	0.68	0.78	0.89	b ₁	0.90	0.98	1.10
b ₂	5.20	5.33	5.55	c	0.45	0.5	0.55
D ₁	5.98	6.10	6.22	D ₂	--	4.00	--
E	6.47	6.60	6.73	E ₁	5.10	5.28	5.45
e	--	2.28	--	e ₁	--	4.57	--
H _D	9.60	10.08	10.40	L	2.75	2.95	3.05
L ₁	--	0.50	--	L ₂	0.50	--	1.10
w	--	0.20	--	y	0.20	--	--